

COS433/Math 473: Cryptography

Mark Zhandry

Princeton University

Fall 2020

Announcements/Reminders

HW2 due Today

- Submit through Gradescope

PR1 Due October 6

Previously on COS 433...

Confusion/Diffusion Paradigm

Confusion/Diffusion Paradigm

Third Attempt: Repeat multiple times!

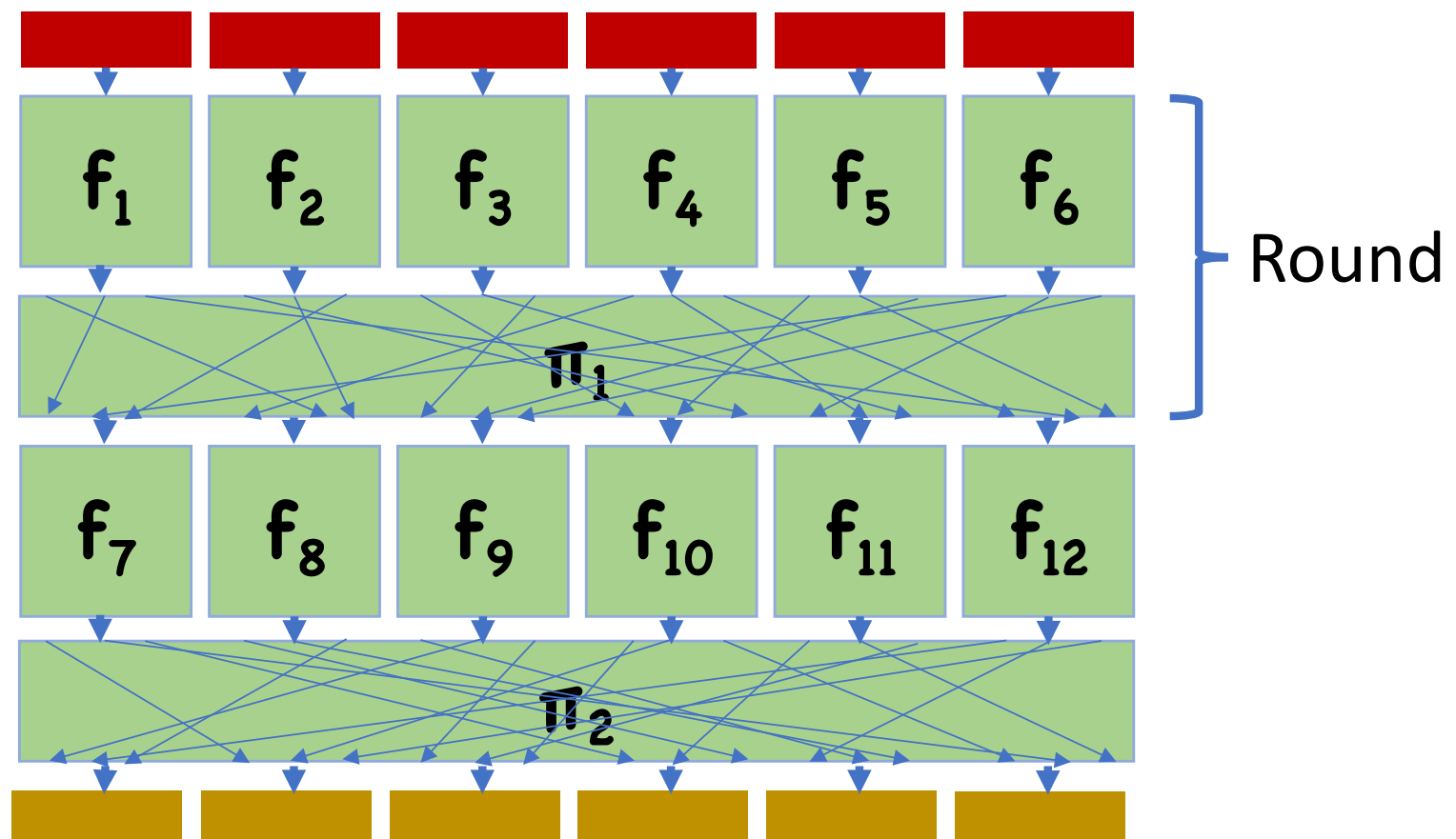

Confusion/Diffusion Paradigm

While single round is insecure, we've made progress

- Each bit affects 8 output bits

With repetition, hopefully we will make more and more progress

Confusion/Diffusion Paradigm

With 2 rounds,

- Each bit affects 64 output bits

With 3 rounds, all 128 bits are affected

Repeat a few more times for good measure

Limitations

Describing subs/perms requires many bits

- Key size for r rounds is approximately $2^8 \times \lambda \times r$
- Ideally want key size to be **128** (or **256**)

Idea: instead, fix subs/perms

- But then what's the key?

Substitution Permutation Networks

Variant of previous construction

- Fixed public permutations for confusion (called a substitution box, or S-box)
- Fixed public permutation for diffusion (called a permutation box, or P-box)
- XOR “round key” at beginning of each round

Substitution Permutation Networks

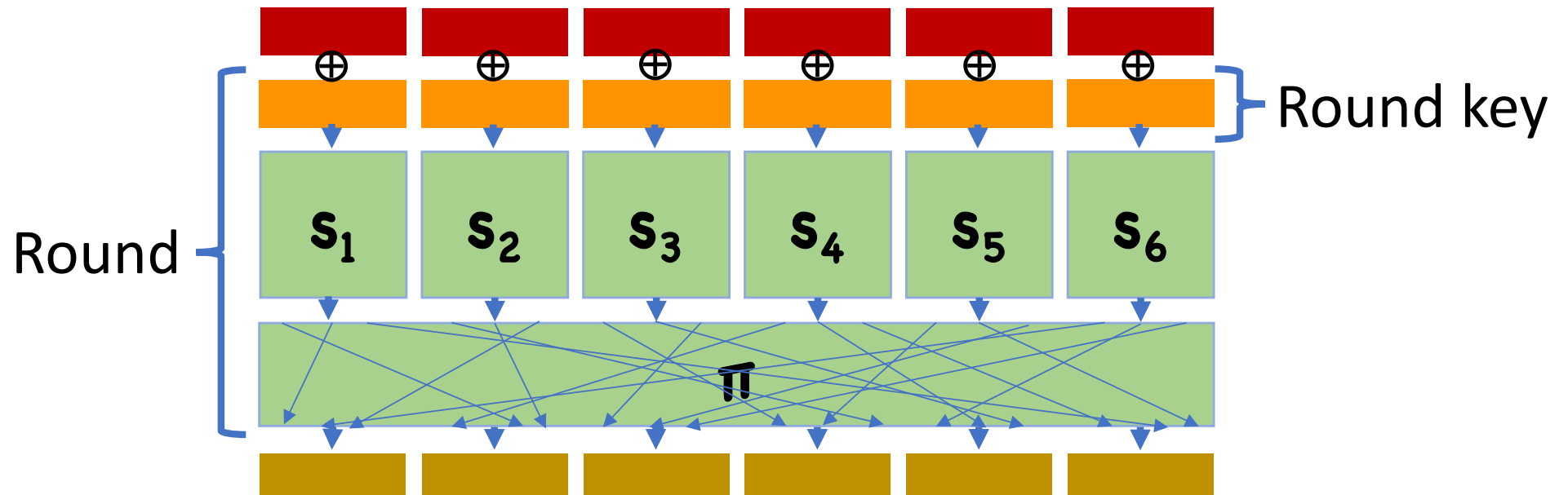

Substitution Permutation Networks

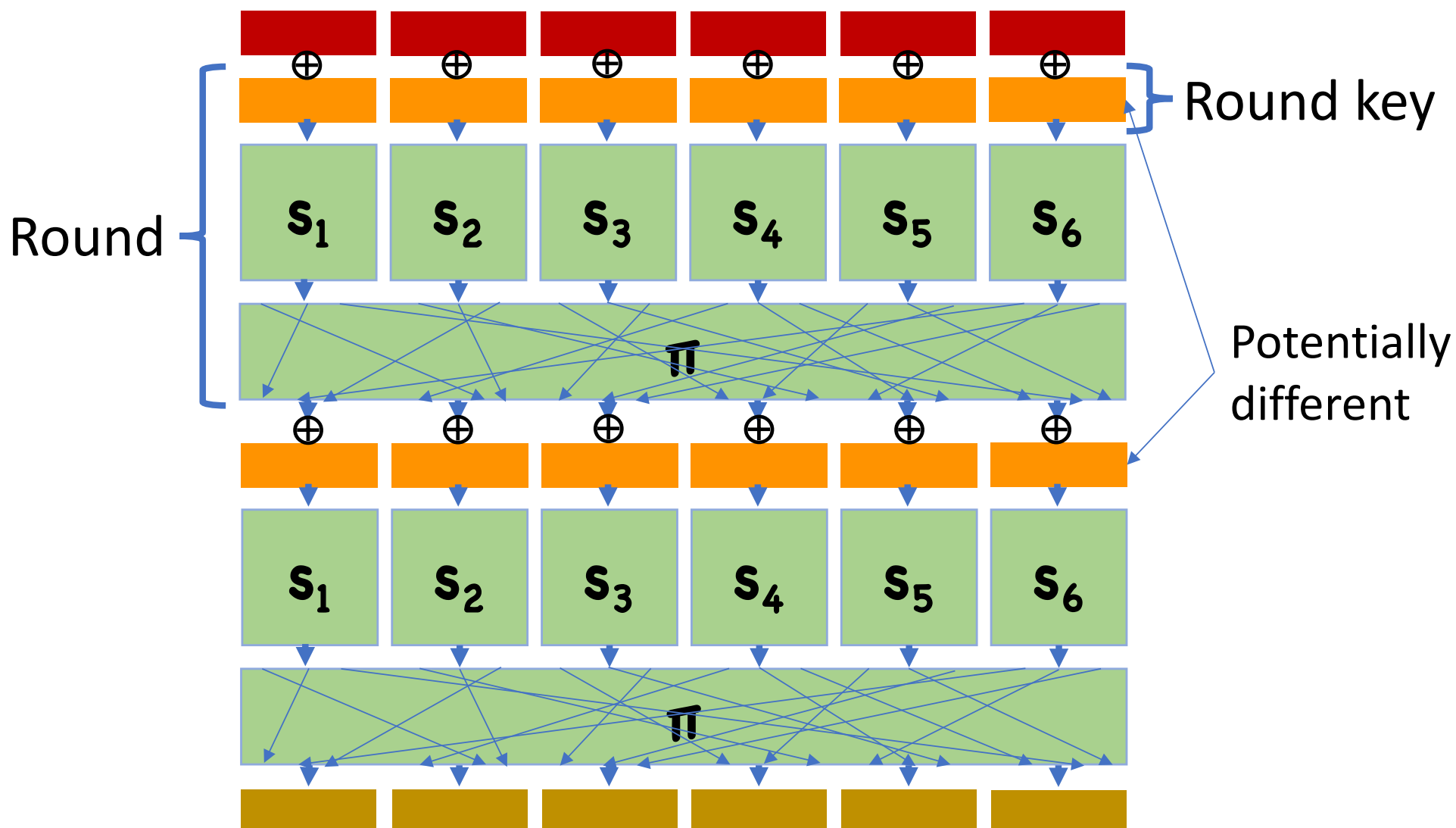

Substitution Permutation Networks

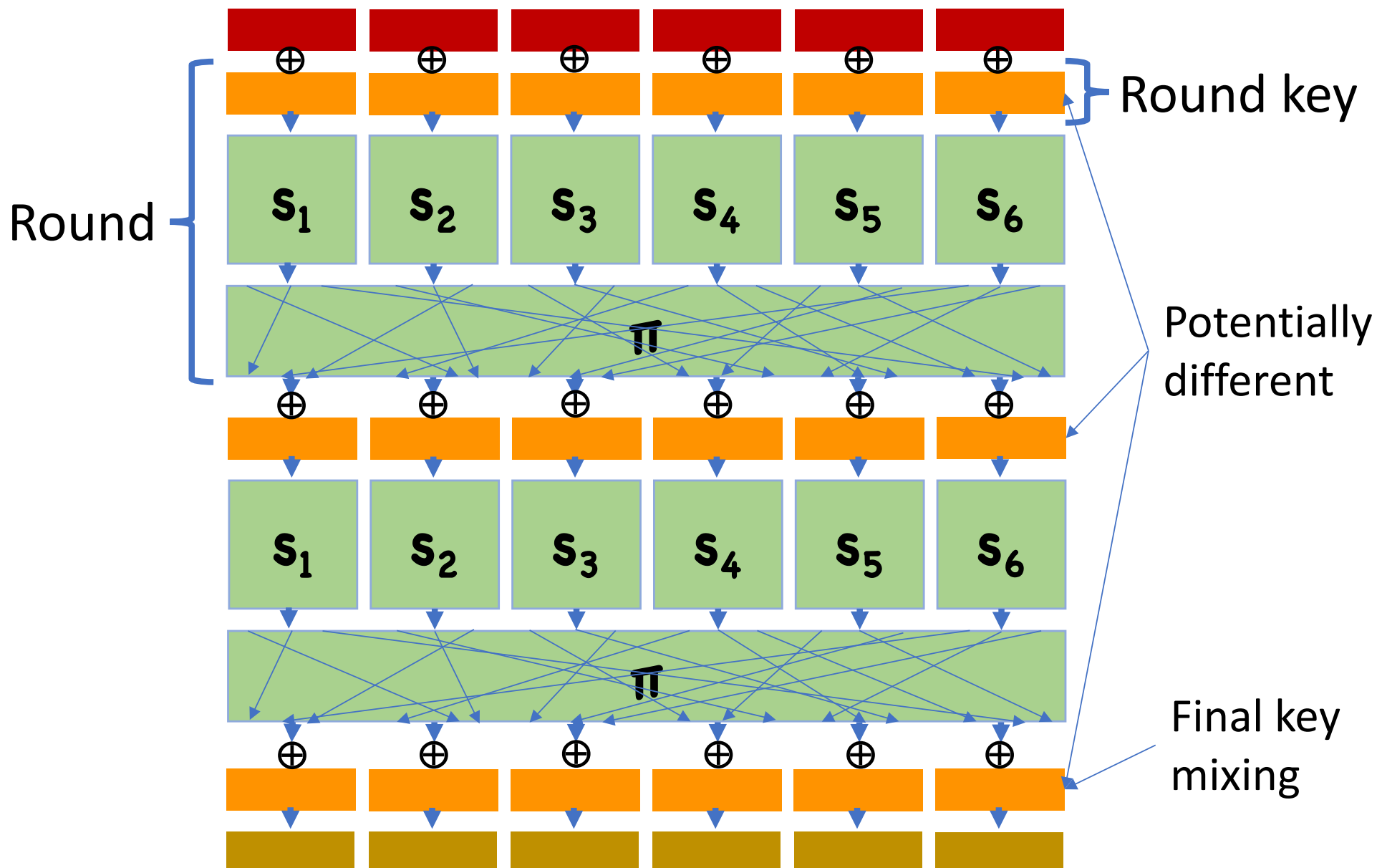

Substitution Permutation Networks

To specify a network, must:

- Specify S-boxes
- Specify P-box
- Specify key schedule (how round keys are derived from master)

Choice of parameters can greatly affect security

Designing SPNs

Avalanche Affect:

- Need S-boxes and mixing permutations to cause every input bit to "affect" every output bit

One way to guarantee this:

- Changing any bit of S-box input causes at least 2 bits of output to change
- Mixing permutations send outputs of S-boxes into at least 2 different S-boxes for next round
- Sufficiently many rounds are used

Designing S-Boxes

Random?

- Let x, x' be two distinct 8-bit values
- **$\Pr[S(x) \text{ and } S(x') \text{ differ on a single bit}] = 8/255$**
- Very high probability that some pair of inputs will have outputs that differ on a single bit

Therefore, must carefully design S-boxes rather than choose at random

Linearity?

Can S-Boxes be linear?

- That is, $\mathbf{S}(\mathbf{x}_0) \oplus \mathbf{S}(\mathbf{x}_1) = \mathbf{S}(\mathbf{x}_0 \oplus \mathbf{x}_1)$?

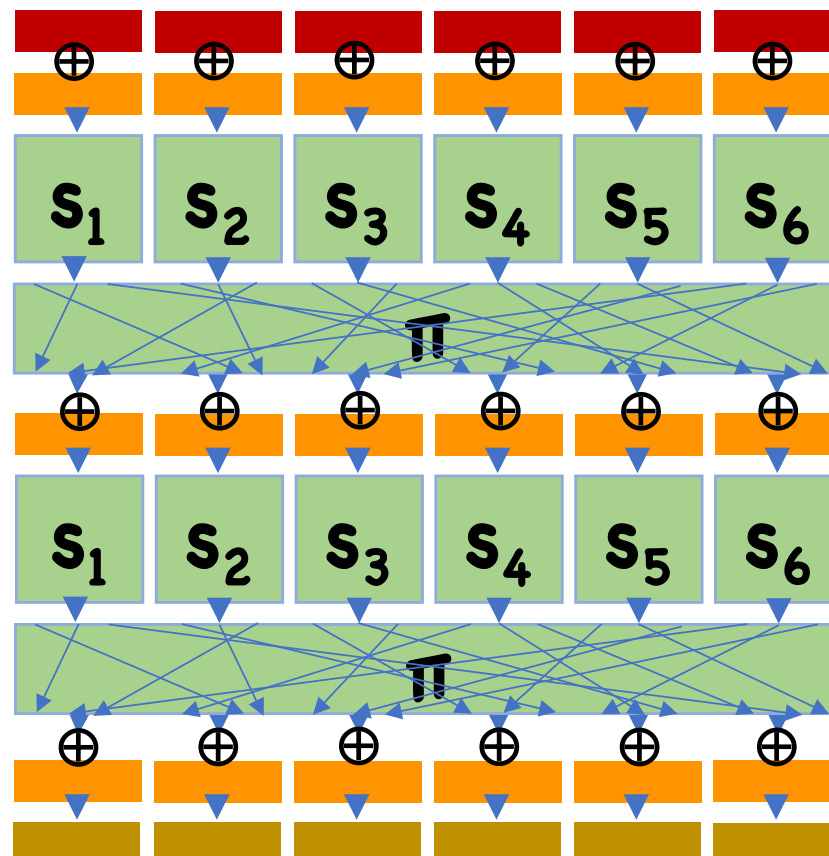

AES

State = **4×4** grid of bytes

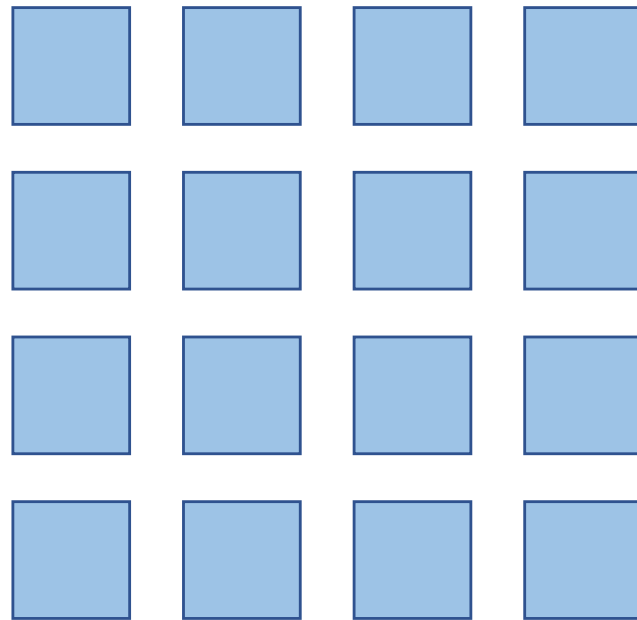

AES

One fixed S-box, applied to each byte

- Step 1: multiplicative inverse over finite field \mathbb{F}_8
- Step 2: fixed affine transformation
- Implemented as a simple lookup table

AES

Diffusion (not exactly a P-box):

- Step 1: shift rows
- Step 2: mix columns

AES

Shift Rows:

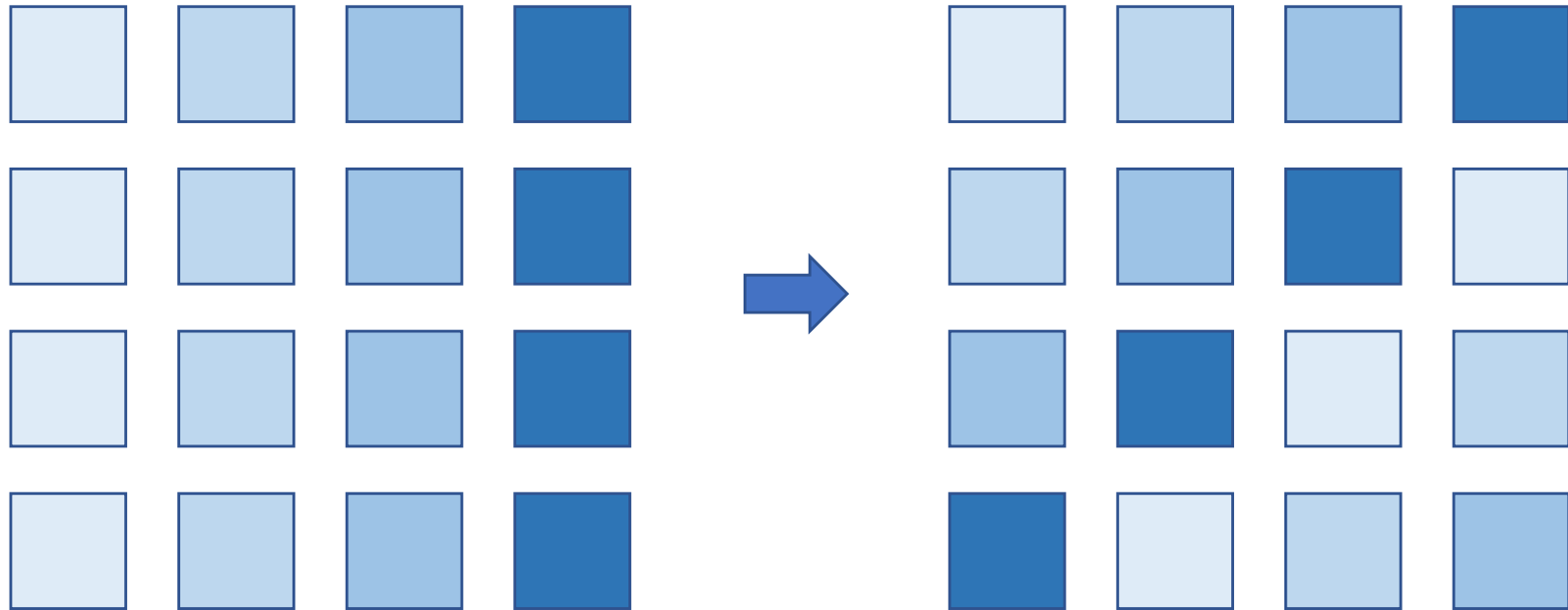

AES

Mix Columns

- Each byte interpreted as element of \mathbb{F}_8
- Each column is then a length-4 vector
- Apply fixed linear transformation to each column

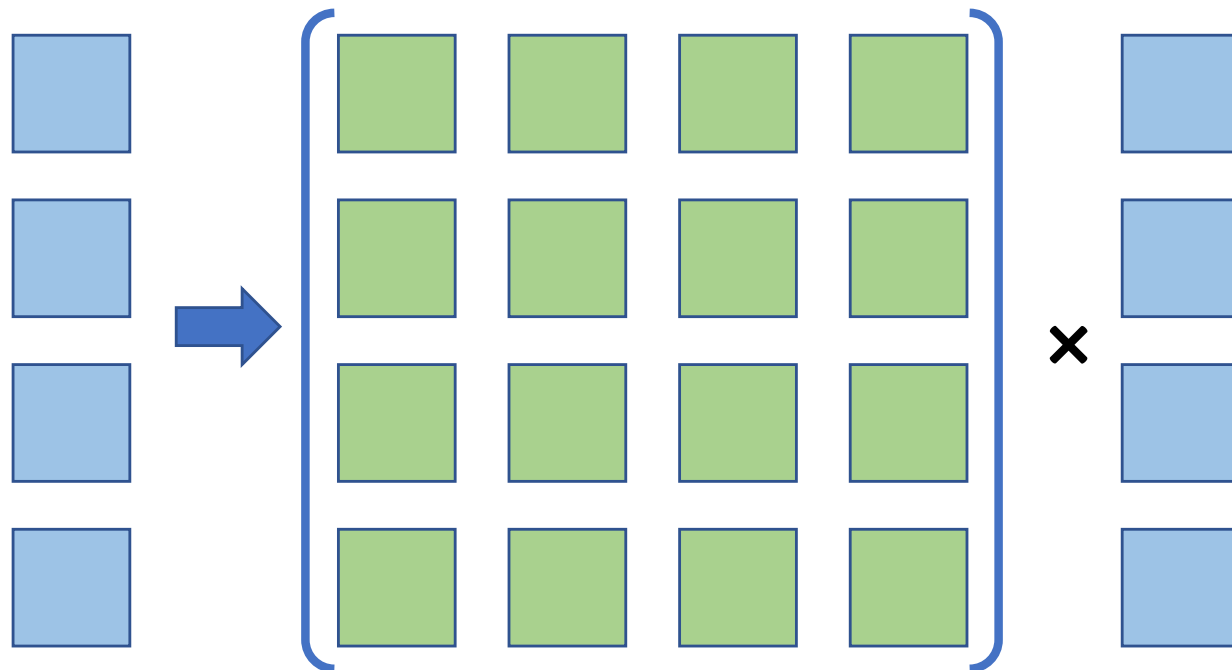

AES

Number of rounds depends on key size

- 128-bit keys: 10 rounds
- 192-bit keys: 12 rounds
- 256-bit keys: 14 rounds

Key schedule:

- Won't describe here, but involves more shifting, S-boxes, etc
- Can think of key schedule as a weak PRG

Feistel Networks

Feistel Networks

Designing permutations with good security properties is hard

What if instead we could built a good permutation from a function with good security properties...

Feistel Network

Convert functions into permutations

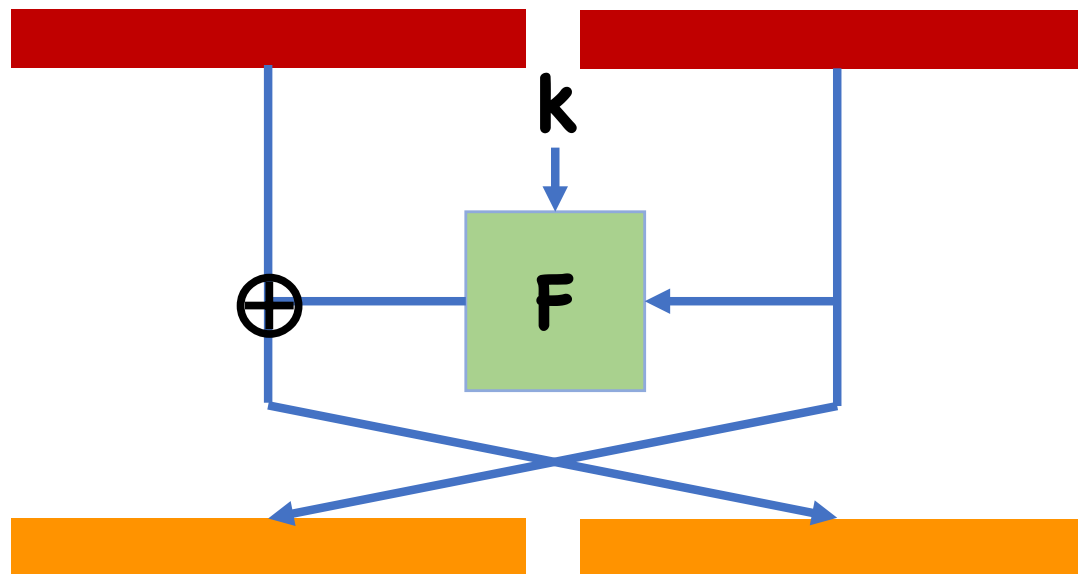

F public
k secret

Can this possibly give a secure PRP?

Feistel Network

Convert functions into permutations

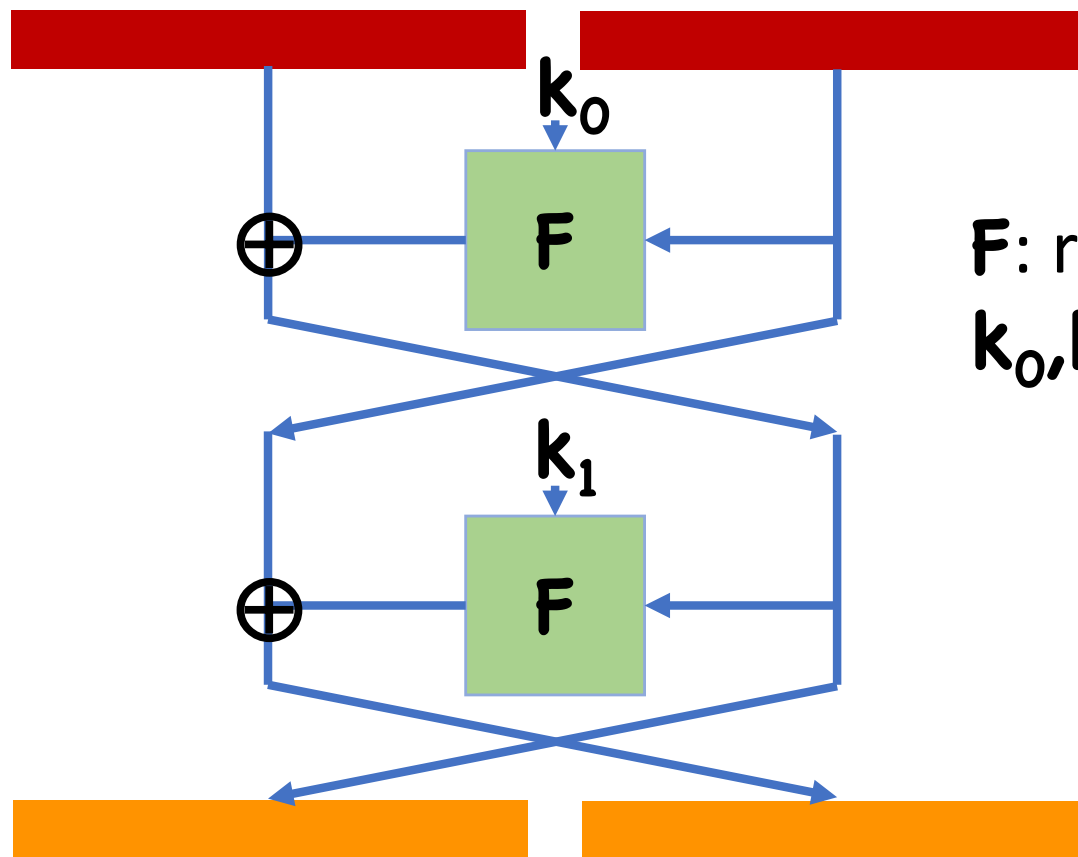

F : round function
 k_0, k_1 : round keys

Feistel Network

Depending on specifics of round function, different number of rounds may be necessary

- Number of rounds must always be at least 3
- Maybe need even more for weaker round functions

Luby-Rackoff

3-round Feistel where round function is a PRF

Theorem: If F is a secure PRF, then 3 rounds of Feistel (with independent round keys) give secure PRP.

- Proof non-trivial, won't be covered in this class

Limitations of Feistel Networks

Turns out Feistel requires block size to be large

- If number of queries $\sim 2^{\text{block size}/2}$, can attack

Format preserving encryption:

- Encrypted data has same form as original
- E.g. encrypted SSN is an SSN
- Useful for encrypting legacy databases

Sometimes, want a very small block size

Constructing Round Functions

Ideally, "random looking" functions

Similar ideas to constructing PRPs

- Confusion/diffusion
- SPNs, S-boxes, etc

Key advantage is that we no longer need the functions to be permutations

- S-boxes can be non-permutations

DES

Block size: 64 bits

Key size: 56 bits

Rounds: 16

!!!

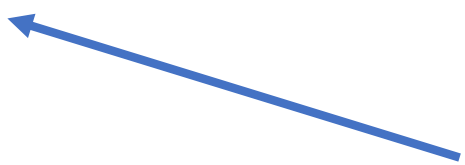

DES

Key Schedule:

- Round keys are just 48-bit subsets of master key

Round function:

- Essentially an SPN network

DES S-Boxes

8 different S-boxes, each

- 6-bit input, 4-bit output
- Table lookup: 2 bits specify row, 4 specify column

- Each row contains every possible 4-bit output
- Changing one bit of input changes at least 2 bits of output

DES History

Designed in the 1970's

- At IBM, with the help of the NSA
- At the time, many in academia were suspicious of NSA's involvement
 - Mysterious S-boxes
 - Short key length
- Turns out, S-box probably designed well
 - Resistant to "differential cryptanalysis"
 - Known to IBM and NSA in 1970's, but kept secret
- Main weakness is the short key length
 - Maybe secure in the 1970's, definitely not today

DES Security Today

Seems like a good cipher, except for its key length and block size

What's wrong with a small block size?

- Remember for e.g. CTR mode, IV is one block
- If two identical IV's seen, attack possible
- After seeing q ciphertext, probability of repeat IV is roughly $q^2/2^{\text{block length}}$
- Attack after seeing \approx billion messages

3DES: Increasing Key Length

3DES key = Apply DES three times with different keys

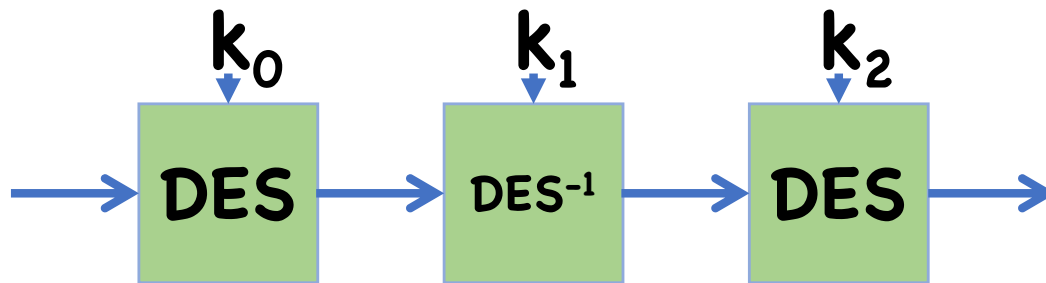

Why three times?

- Later: “meet in the middle attack” renders 2DES no more secure than 3DES

Why inverted second permutation?

Attacks on block ciphers

Brute Force Attacks

Suppose attacker is given a few input/output pairs

Likely only one key could be consistent with this input/output

Brute force search: try every key in the key space, and check for consistency

Attack time: $2^{\text{key length}}$

Insecurity of 2DES

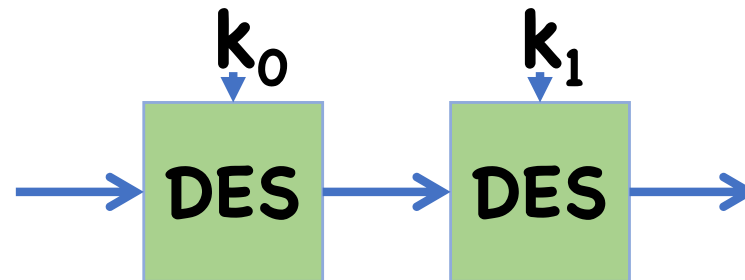

DES key length: 56 bits

2DES key length: 112 bits

Brute force attack running time: 2^{112}

Meet In The Middle Attacks

For 2DES, can actually find key in 2^{56} time

- Also $\approx 2^{56}$ space

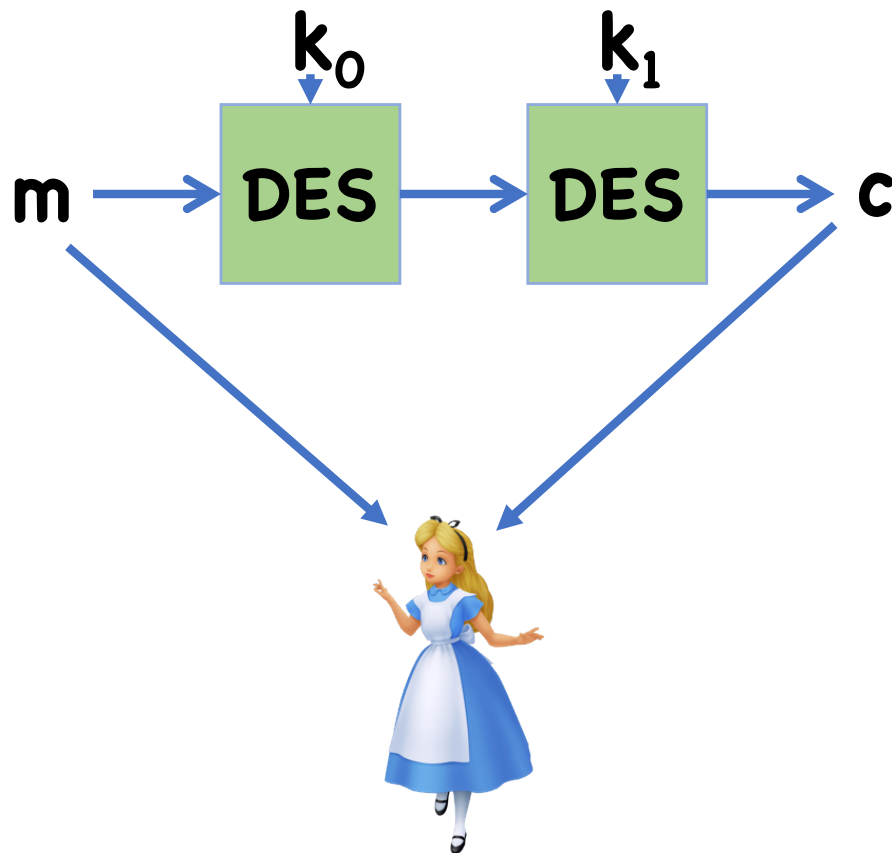

Meet In The Middle Attacks

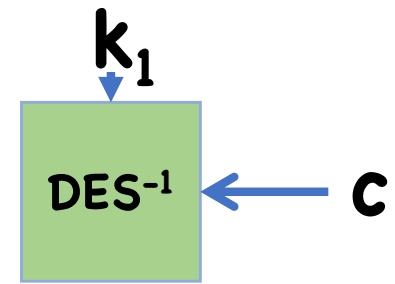
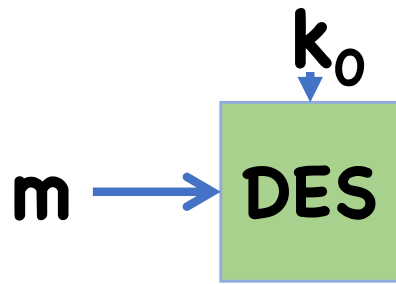

k_0	$d = \text{DES}(k_0, m)$
0	52
1	93
2	03
3	96
4	20
5	49
...	...

k_1	$d = \text{DES}^{-1}(k_1, m)$
0	69
1	10
2	86
3	49
4	99
5	08
...	...

Meet In The Middle Attacks

Complexity of meet in the middle attack:

- Computing two tables: time, space $2 \times 2^{\text{key length}}$
- Slight optimization: don't need to actually store second table

On 2DES, roughly same time complexity as brute force on DES

MITM Attacks on 3DES

MITM attacks also apply to 3DES...

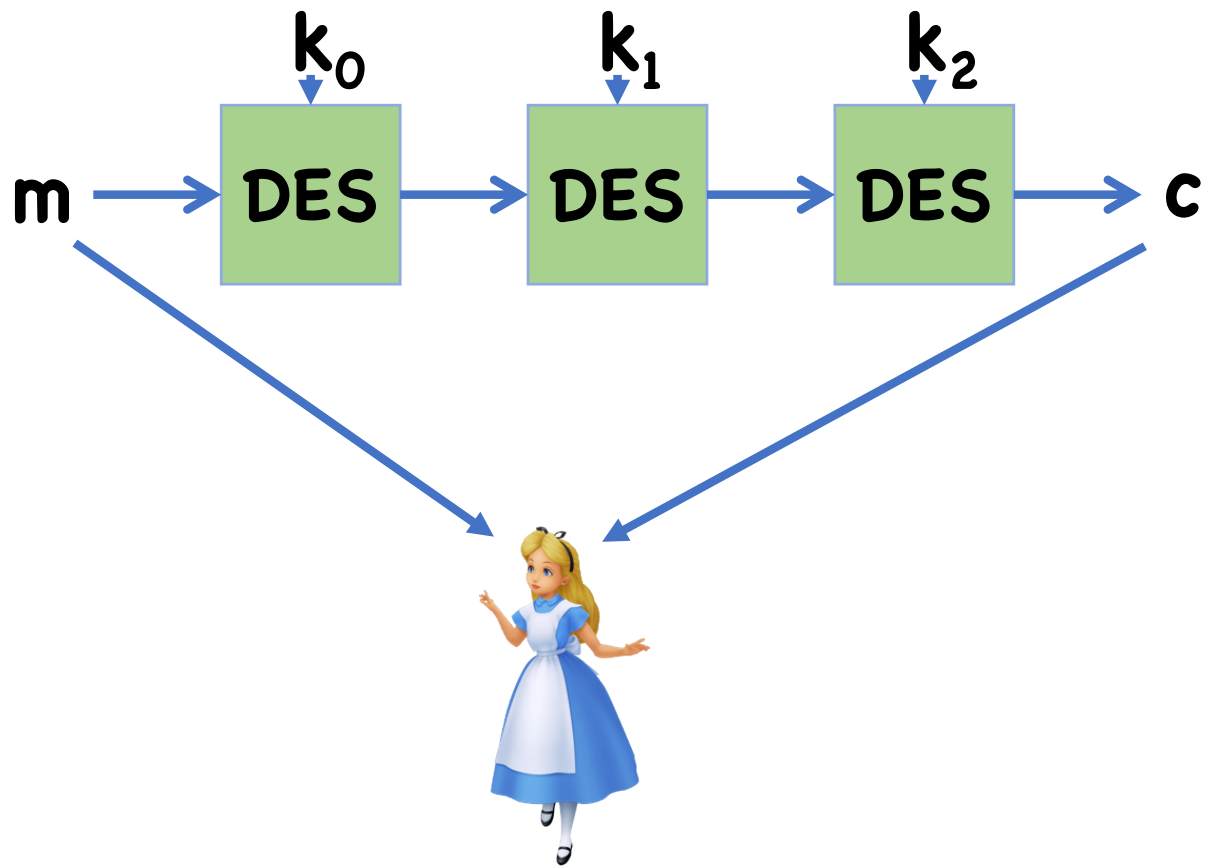

MITM for 3DES

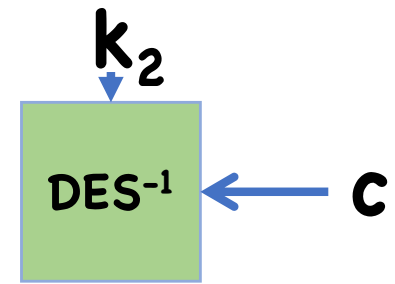
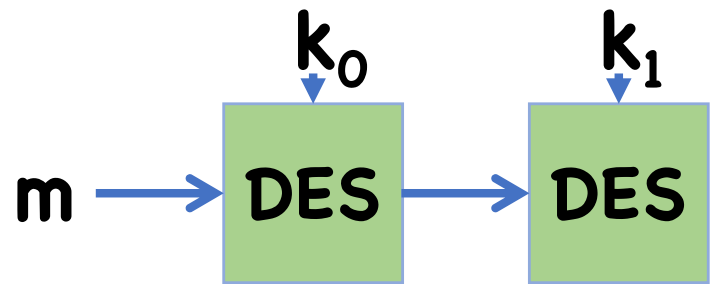

k_0	k_1	$d = \text{DES}(k_0, m)$
0	0	52
0	1	93
...	...	03
5	6	96
5	7	20
5	8	49
...

k_2	$d = \text{DES}^{-1}(k_2, m)$
0	69
1	10
2	86
3	49
4	99
5	08
...	...

MITM for 3DES

No matter where “middle” is, need to have two keys on one side

- Must go over 2^{112} different keys

Space?

While 3DES has 168 bit keys, effective security is 112 bits

Generalizing MITM

In general, given r rounds of a block cipher with t -bit keys,

- Attack time: $2^{\lceil r/2 \rceil t}$
- Attack space: $2^{\lceil r/2 \rceil t}$

Announcements/Reminders

HW2 due today

- Submit through Gradescope

PR1 Due October 6